

Aotoro®

ED60 直流远距离型

Long sensing distance type

INSTRUCTION MANUAL 使用说明书

PHOTOELECTRIC SENSOR
光电开关



A2302-12

Model selectable 型号选择

Detecting type 传感方式	Appearance 外型	Detecting distance 检测距离	Operation mode 操作模式	Output输出	Model型号
Diffuse reflective 直接反射		2m	Light-ON /Dark-ON	NPN output	ED60-DS2C4
Retroreflective 反射板反射		7m	Light-ON /Dark-ON	NPN output	ED60-R7C4
Through-beam 对射		10m	Light-ON /Dark-ON	NPN output	ED60-10C4

Specification 规格

Model 型号	Diffuse reflective type 直接反射	Retroreflective type 反射板反射	Through-beam type 对射
		ED60-DS2C4	ED60-R7C4
Detecting distance 探测距离	0-2m	0-7m	0-10m
Detecting target 探测物体		Opaque materials of Min. ϕ 60 直径 ϕ 60以上不透明体	Opaque materials of Min. ϕ 20 直径 ϕ 20以上不透明体
Operation mode 操作模式	Selectable Light ON or Dark ON by control wire 可用控制线选择 入光 ON 或遮光 ON		
Response time 响应时间	Max. 1ms		
Power supply 电源电压	10-30VDC		
Current consumption 静态电流	Max. 15mA		
Control output 控制输出	NPN open collector output: Max. 200mA 集电极开路输出		
Residual voltage 残留电压	Max. 1.5V		
Circuit protection 电路保护	Short-circuit protection, Reverse polarity protection 短路保护, 电源逆接保护		
Insulation resistance 绝缘	Min. 20M Ω (500VDC)		
Dielectric strength 耐电压	1500VAC 50/60HZ for 1 minute		
Ambient illumination 使用环境照度	Sunlight 太阳光: Max. 10000lx, Incandescent lamp 日光灯: Max. 3000lx		
Operating temperature 使用环境温度	-20 to 60°C (non-freezing condition 不结冰)		
Ambient humidity 使用环境湿度	35 to 85%RH		
Protection 保护结构	IP64		
Material 材质	Case: ABS, Lens: PC		

Ordering information 订购信息

ED60-DS2C4

Output 输出状态	1	Light ON 入光 ON
	2	Dark ON 遮光 ON
	4	Selectable Light ON or Dark ON by control wire (可通过控制线选择入光 ON 或遮光 ON)
Output 输出构成	C	DC NPN output
	B	DC PNP output
	M	Free power relay output 自由电源触点输出型
	D	DC power relay output 直流电源触点输出型
	A	AC power relay output 交流电源触点输出型
Z		AC 2-wire 交流电源二线控制型
Detecting distance 检测距离	2	2m
	5	5m
	10	10m
Detecting type 传感方法	DS	Diffuse reflective 直接反射
	R	Retroreflective 反射板反射
		Through-beam 对射
Serial number 设计序号	60	Side length of head 探测头边长
Photoelectric switch 光电开关	EK	Relay contact output 触点输出型
	ER	Cylindrical type 圆柱型
	ED	DC univesal type 通用型
	EU	Groove shape type 槽型

Control output diagram 控制输出图

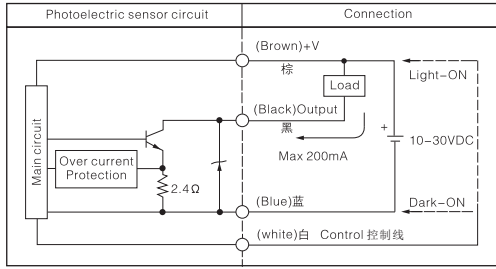

Selectable Light ON/Dark ON mode by control wire,
通过控制线选择入光ON或遮光ON

Operation mode 操作图解

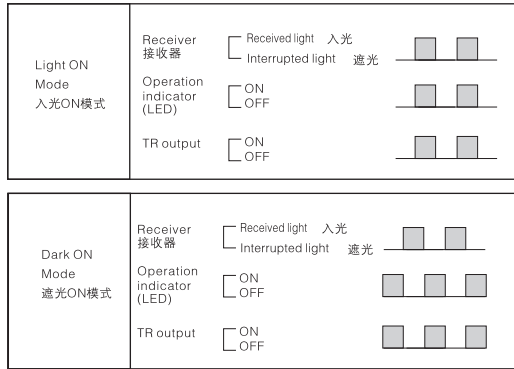

Connections 连接图

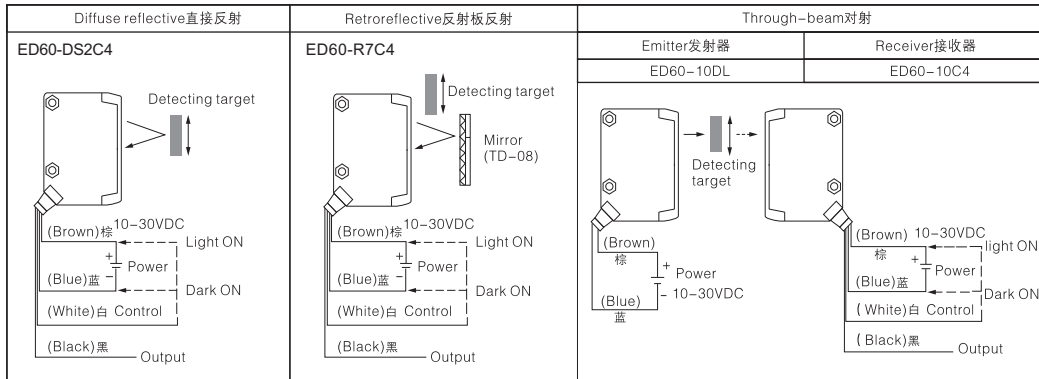

Dimensions 尺寸(unit:mm)

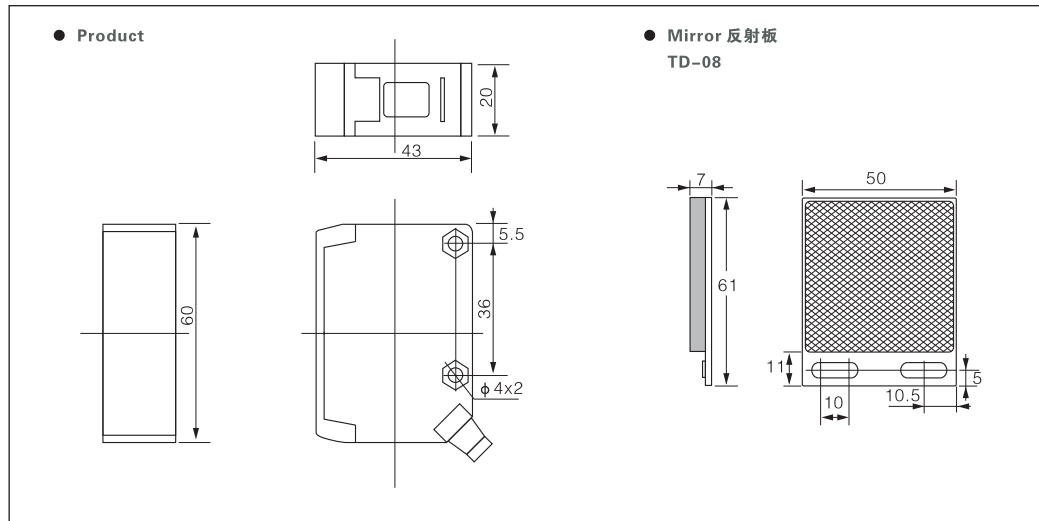

Installation and sensitivity adjustment 安装及感光度调节

Please supply the power to the sensor after installing the emitter and the receiver in face to face, and then adjust an optical axis and the sensitivity as follow; 面对面安装好发射器和接收器后请给传感器提供电源, 然后按以下说明调整光轴及感光度

● Diffuse reflective type 直接反射型

- Even though the diffuse reflective type is set at max. sensitive position. The sensitivity of the sensor must be adjusted in accordance with the existence of the reflective material in background. 即使是直接反射型也要进行最大感光度的设置。传感器感光度的调节必须和反射材料的背景保持一致

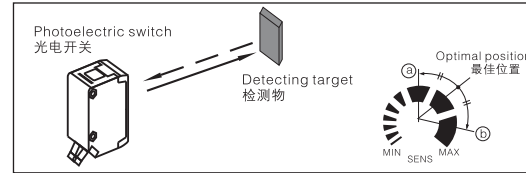

- Set the target at the area of the detecting, then turn the adjuster down to point ① where the indicator just turns on from Min. position of the adjuster. 安装检测物到可检测区域, 调节旋钮从最小位开始调节, 当调节到指示灯刚好亮时, 此时的旋钮位置为 ① 点
 - Take the target out of the sensing area, then turn the adjuster until point ② where the indicator turns on. If the indicator does not turn on, max. position is point ③. 从感应区域拿开检测物, 调节到指示灯亮时, 此时的旋钮位置为 ②, 如果指示灯一直不亮, 那么旋钮的最大位置就是 ③ 的位置
 - Set the adjuster at the center of two switching point ①, ②. ①, ② 两点中间位置就是最佳位
- ※ The detecting distance indicated in the specification chart is that of non-glossy white paper in the target size 100×100mm.
※ 检测物是规定的100×100mm的白色无光泽纸

● Retroreflective 反射板反射

- Supply the power to the photoelectric sensor, after setting the photoelectric sensor and the mirror (TD-08) in face to face. 将发射器和反射板镜面对面安装, 并调节光轴位置和灵敏度后连接电源
- Set the photoelectric sensor in the position which indicator turns on, as adjusting the mirror or the sensor right and left, up and down. 调节反射板上下左右位置, 使传感器的指示灯变亮后固定

Precautions in using the product 使用注意事项

NOTE 注意

Be sure to follow the safety precautions below for adder safety

以下项目在安全确保方面非常重要, 请务必遵守。

- Do not use the sensor under the explosive or flammable gas environment. 请不要在具有可燃性、爆炸性气体的环境下使用。
- Never disassemble, repair or tamper the product. 请勿拆卸、修理、改造本产品。
- Keep the supply voltage within the specified area. 电源电压必须在额定值内。
- Use the load under the specified area. 请使用额定值以下的负荷。

Caution for using 正确使用方法

- Do not use the product under the following conditions. 请不要在以下的环境中使用。

- In the place of the direct sunlight. 日光直射场所。
- In the place where humidity is high and condensation may occur. 湿度高或易结露场所。
- In the place of the corrosive gas exists. 含腐蚀性气体场所。
- In the place where vibration or shock is directly transmitted to the product. 振动或冲击能直接传送到传感器场所。

2. Connection and Mounting 连接和安装

- Be sure that before giving the power, the supply voltage is less than the maximum rated supply voltage.

通电前请确认供电电源电压小于最大允许电源电压。

- There are some cases where the photoelectric switch cable is unavoidably laid in a tube or duct together with a hightension or power line. This causes an induction, possibly resulting in malfunction or damage. In principal, the cable should be separately laid or shielded.

传感器导线和动力线或电力线装在同一配管中使用时, 会受到干扰, 有误动作甚至被损坏。原则上传感器导线必须单独放置或者被屏蔽。

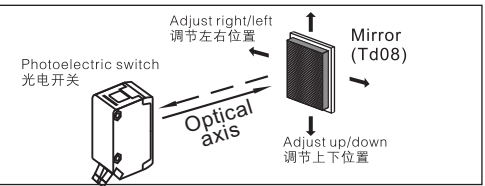

- Fix both units tightly after checking that the unit detects the target. 可靠安装两者后, 并校对其检测到目标
 - If use more than 2 photoelectric sensors in parallel, the space between them should be more than 30cm. 如果并行同时使用2个以上光电传感器, 那么它们的间距应大于30cm
 - If reflectance of target is higher than non-glossy white paper, it might cause malfunction by reflection from the target when the target is near to photoelectric sensor. Therefore put enough space between the target and photoelectric sensor or the surface of target should be installed at an angle of 30 to 45 against optical axis. 如果被检测物体的反射率比反射板镜面的更高, 它会发生误动作。因此在传感器和被测物体之间要留有足够的空间, 或者把被测物体和光轴成30-45度的角度
- ※ Sensitivity adjustment: Please see the diffuse reflective type. 灵敏度调节时请参照直接反射型

● Through-Beam type 对射型

- Supply the power to the photoelectric sensor, after installing the emitter and the receiver face to race. 面对面的安装好发射器及接收器后请给传感器提供电源
- Set the receiver in center of position where indicator turns on, when adjusting the receiver and the emitter right and left, up and down. 调整接收器和发射器的上下左右位置, 在指示灯亮时, 在中心位置安装好接收器
- Fix both units tightly after checking that the units detect the target. 检查检测目标后安装牢固传感器

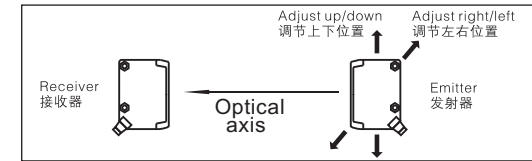

- For extending wires, whose cross section is greater than 0.3sqmm and the length less than 100m. 延长导线必须使用截面积0.3mm²以上、长度100m以下导线。
- Do not pull wire strongly. 导线请勿用力拉扯。
- Excessive force (hitting by hammer, etc.) Should not be put on the sensors because it may damage its water-resistance. 安装传感器时, 请勿使传感器受剧烈外力 (如用锤击打等), 这样就有可能破坏传感器防水保护性能。
- Power supply 电源
When using a commercially available switching regulator, be sure to ground the FG (Frame Ground) terminals. 使用市场上销售的开关整流器时, 请将FG (Frame Ground) 端子接地。
- Power supply reset time 电源重新调整时间
The photoelectric switch will begin sensing no later than 100ms after the power is turned on. If the load and the photoelectric switch connected to different power supply, the photoelectric switch must be always turned on first. 从接通电源到传感器可正常进行检出的时间是100ms后再使用。负载和传感器接不同电源时, 一定要先接通传感器的电源
- Turning off the power supply 电源关闭
When turning off the power, output pulse may be generated. We recommend turning off the power supply of the load or load line first. 电源关闭时, 可能会出现输出脉冲, 所以我们建议先关闭负载或负载线的电源

浙江欧迪龙电子科技有限公司
Zhejiang Aotero Electronic Technology CO., LTD
ADD: Liuhuang Road 2188#, Liushi town, Yueqing city, Zhejiang province. PRC 325604
浙江省乐清市柳市镇柳黄路2188号
TEL: 86-577-61758688 FAX: 86-577-62757002
Http://www.aotero.com E-mail: aotero@aotero.com